

PARKoKIT

TOUCHLESS PARKING SYSTEM

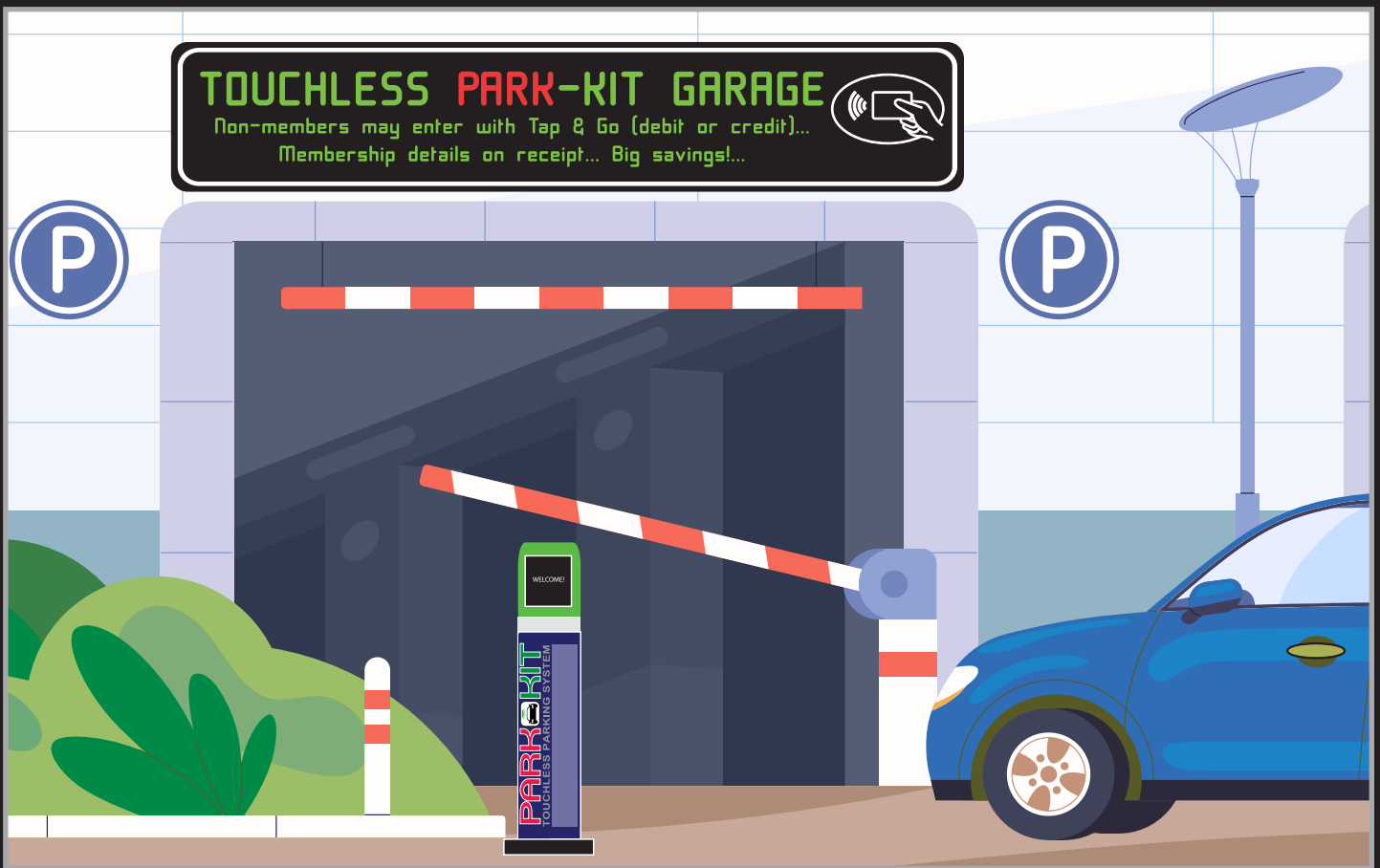

PARK-KIT

TOUCHLESS PARKING SYSTEM

Drive into the Future of Parking with the PARK-KIT System

Our revolutionary solution is designed to prioritize safety, convenience, and sustainability, making your job as a parking lot manager easier than ever. Say goodbye to the headaches of managing parking spaces as **PARK-KIT** efficiently guides drivers to available spots, reducing customer frustration and CO gas emissions. With amenities like WIFI, EV chargers, and special discounts, you'll attract more customers and increase revenue and repeat business.

Member Entry into PARK-KIT Lot

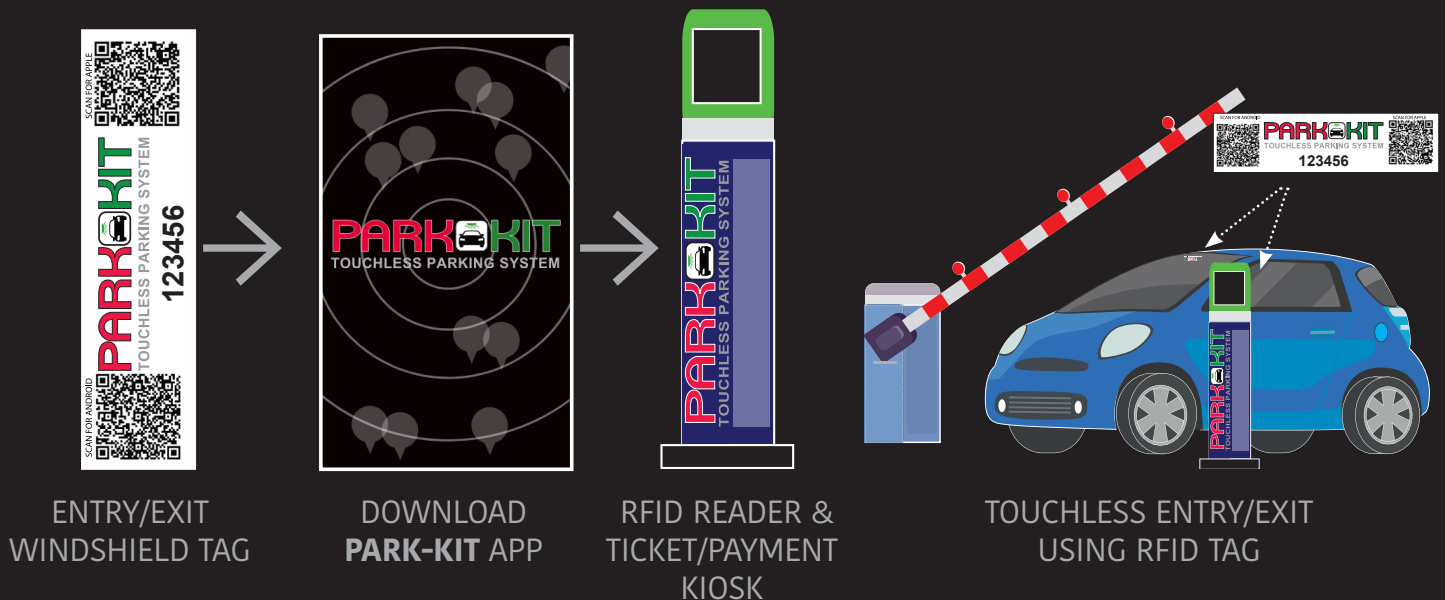

Members with the **PARK-KIT** app and an RFID windshield pass can enter and exit any **PARK-KIT** lot automatically. New members can get multiple windshield stickers from the entry/exit payment kiosks.



The PARK-KIT Advantage



Every **PARK-KIT** lot has high speed WIFI everywhere. Drivers can use it in the comfort of their cars.

Non-members can make tap-and-go payments to open the gate with enabled credit or banking cards and are issued a ticket with a QR code to download the **PARK-KIT** app. If non-members don't apply for membership they tap-and-go to leave where a payment receipt with the **PARK-KIT** app QR code is issued.

In this way parking payments are guaranteed and non-members are reminded of the benefits of membership.

Non-Member Entry to PARK-KIT Lot

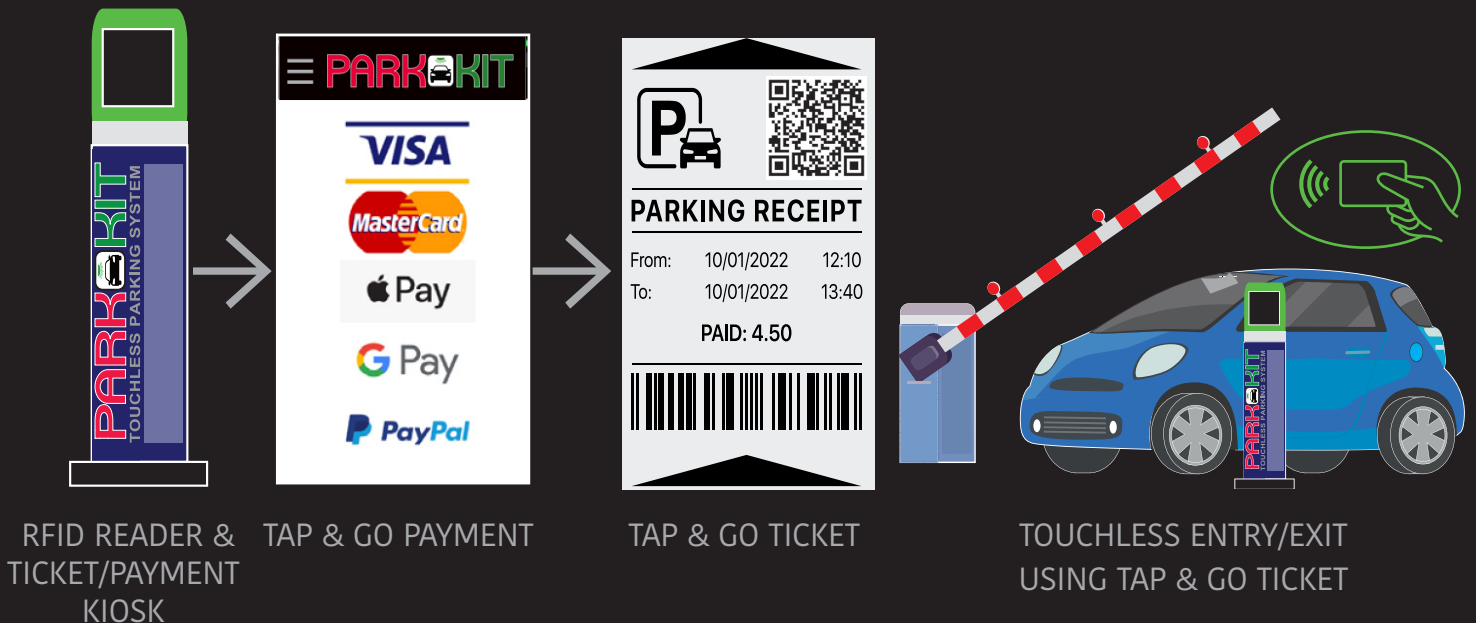

These are the tickets issued at entry and exit that non-members, without their RFID passports, take to open the barrier gates. There is an Apple QR code on one side and an Android QR code on the other.

The PARK-KIT Advantage

All member's information is stored securely on **GOOGLE PAY'S CLOUD** Platform.



PARK-KIT

TOUCHLESS PARKING SYSTEM

How the PARK-KIT Guidance System works

As drivers enter the parking area, flashing colored indicators attached to the lights direct them down aisles to empty parking spaces. Each aisle light monitors up to 6 spaces, 3 on each side of the aisle. The actual colors of our empty space flashing indicators are shown below. When all 6 spaces are full, the colored indicators turn **solid red**.

EMPTY



REGULAR SPACE

OCCUPIED



DISABLED SPACE

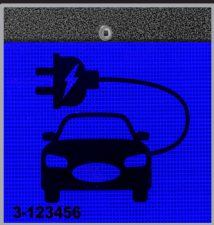

ELECTRIC SPACE

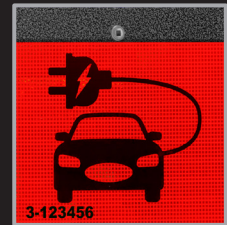

SPECIALTY SPACE



The PARK-KIT Advantage

PARK-KIT APP USERS get their own QR code which allows for the seamless payment of UPGRADE SERVICES like charging stations, car detailing or other specialty offerings.



The PARK-KIT App is easy to download

For our members who have downloaded this app, there is no lining up for payment kiosks, no fumbling with credit cards, no worries about parking overtime, this is a once and forever, seamless, parking experience. **See the easy to access functions of our app below:**



START PAGE

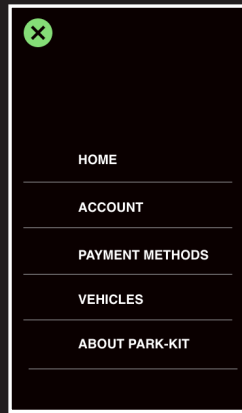

MENU

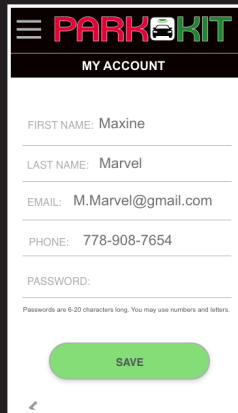

MY ACCOUNT

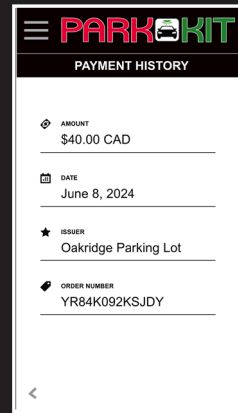

PAYMENT HISTORY

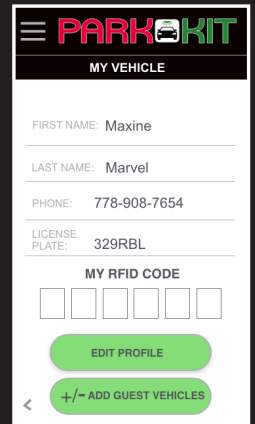

MY VEHICLE

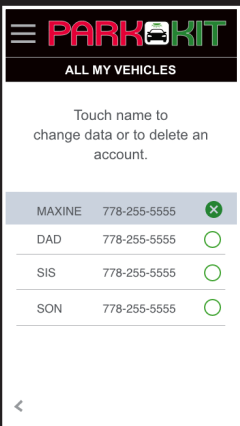

VEHICLES

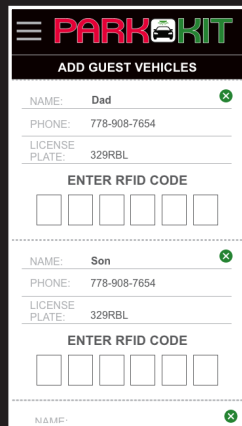

ADD VEHICLES

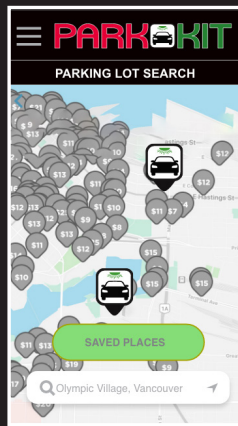

SEARCH

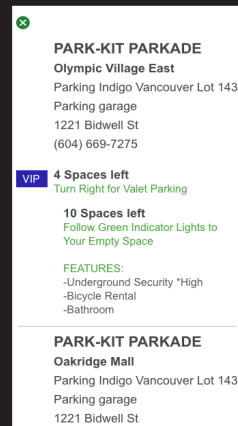

PARKING HISTORY

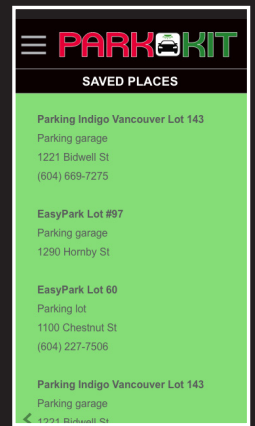

SAVED PARKADES

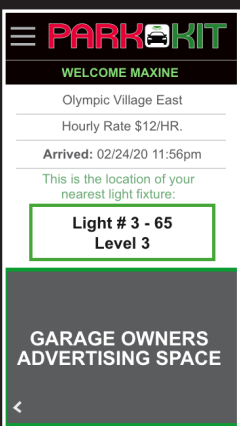

WELCOME

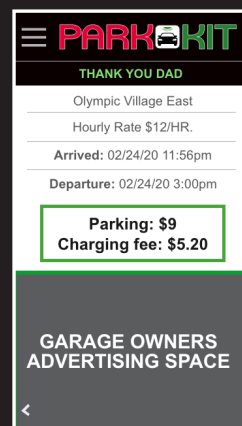

THANK YOU

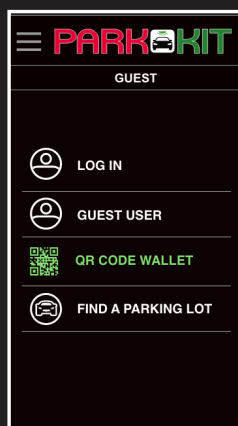

QR WALLET

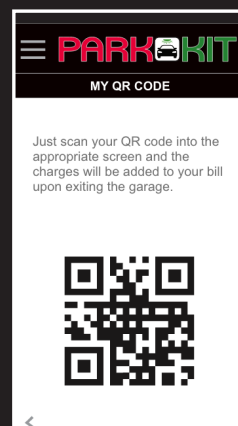

QR CODE

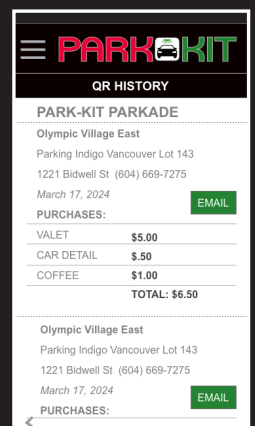

QR HISTORY

Note: There is advertising space at the bottom of the three parking texts that members receive. Garage owners/operators can earn extra revenue by using this space as a “billboard” for other businesses or for promotions/messages to the members.

The Patented PARK-KIT Guidance and Lighting System

Once **PARK-KIT** members have followed colored indicators to a chosen parking area, like an electric vehicle charging station or a handicap parking space, their license plate is “read” by a tiny camera and is then instantly matched with the license number on their RFID passport, which was recorded on Google Cloud as they entered the lot.



Dome Camera with on-board computer

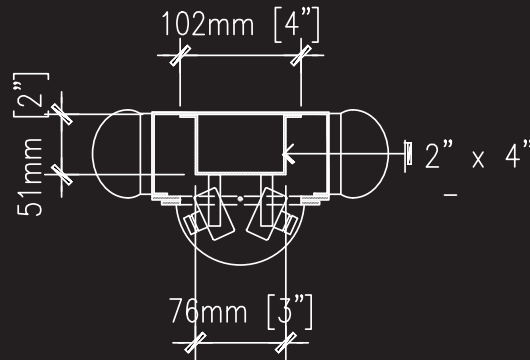

Camera ‘reads’ license plate and matches it to the RFID tag



RFID tag

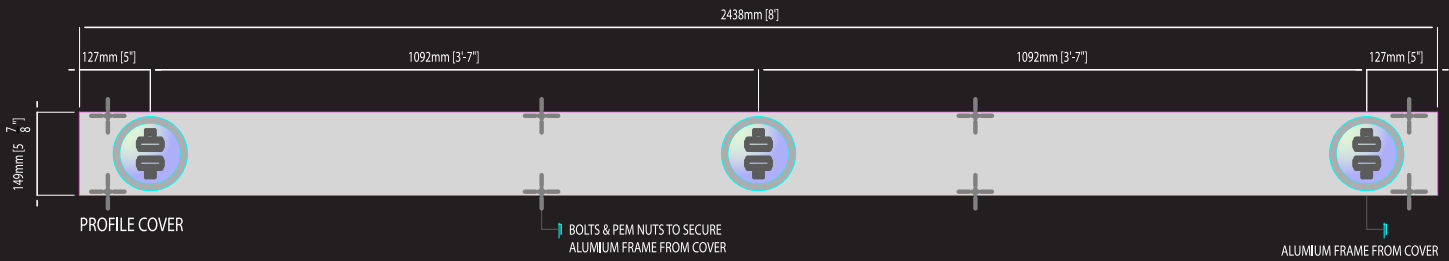

PARK-KIT FLASHING INDICATORS				
	REGULAR	ELECTRIC	HANDICAP	VALET
P1	14	10	7	0
P2	28	1	2	6
P3	53	12	5	0
P4	1	0	0	0

Vacant parking spaces on entry screen



License plates “read” on entry

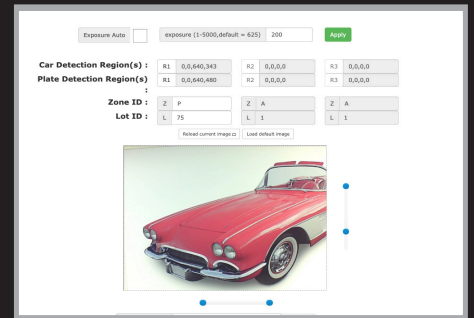

How our Cameras “read” license plates



Screen with occupancy in real time

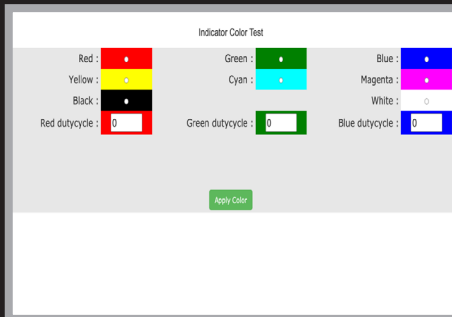

Indicator Colors and Dimming Levels



The Colors and Dimming Levels are easy to change

A Fusion of Technology in one Multi-functional System

On-board Computer:

- A universal WIFI system relays communications between lights.
- Each light contains a quad computer with huge processing power.
- The on-board computer recognizes full or empty spaces.
- This computer works with all the others or can be linked into groups.

Six Cameras per Light:

- Up to six tiny cameras scan up to 6 parking spaces every second.
- If one of these parking spaces is empty, the indicator is green, blue, or mauve.
- If all of these parking spaces are full, the indicator turns red.
- The color of the indicators can be easily changed via a handheld device.
- There are 8 different indicator colors that can be selected.

Control the LED Lighting:

- A motion detector detects movement and dims the lights.
- Any number of lights can be chained together for dimming.
- The highly efficient, dimmable LED side lights provide even lighting.
- No over-vehicle light is needed, reducing the lights by half.

This is our multi-functional WIFI aisle light showing green indicators at each side and camera domes facing parking spaces.

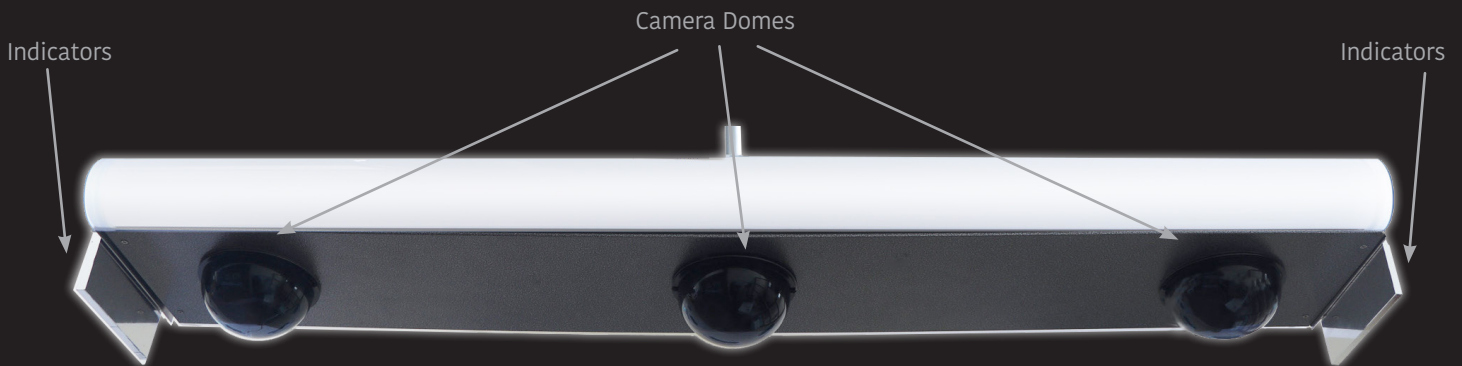

WIFI and function
control system
all-in-one setup





The Advantages of the PARK-KIT System

The Boutique PARK-KIT garage explained:

- **PARK-KIT** reduces frustration and CO gas emissions by guiding drivers to empty spaces.
- **PARK-KIT** saves energy by monitoring CO gas and turning on fans with an add-on function.
- Boutique parking with WIFI and many EV chargers attracts clients.
- Valet space near elevators rents at higher rates and has its own RFID entry gate.
- Washrooms, EV chargers and vending machines payments are made with our QR code wallet.
- Special discounts or "PARKING PACKAGES" can be awarded at lower rates.
- **PARK-KIT** runs on OPEN-SOURCE proprietary software with no other payments to make.
- **PARK-KIT** lights are easy to install and come preprogrammed from our factory.

Special Features Included:

- Significant cost and maintenance savings.
- **PARK-KIT** is priced well below competitors.
- Secure information on Google CLOUD.
- Environmentally friendly LED lighting system.
- Can change parking rates for special events.
- Can protect prime parking areas.
- Can enforce designated worker parking.
- Can monitor unpaid parking.
- Can change parking rates as day progresses.

Add-on Capabilities:

- Can monitor for stolen vehicles via local police reports.
- Can use facial recognition on entry in high crime areas.
- Can photograph drivers on entry and block a different driver on exit.
- **PARK-KIT** can add safety features such as smoke and CO detectors.
- **PARK-KIT** can monitor for after hours intruders and call security.

CONTACT:
admin@park-kit.net

AC/DC LIGHTING
3740 William Street,
Burnaby, British Columbia,
CANADA V5C 3H7

DOWNLOAD THE
PARK-KIT APP HERE:



ANDROID



APPLE

www.PARK-KIT.net or call: TOLL FREE: 1-877-294-2334